

サクシヨンカップマウント

Suction Cup Mount
Support à ventouse

取扱説明書/Operating Instructions/Mode d'emploi/
Manual de instrucciones/Bedienungsanleitung/
Gebruiksaanwijzing/Bruksanvisning/Istruzioni per l'uso/
Manual de Instruc ões/Oδηγίες Χειρουργίας/
Instrukcja obsługi



* 4 4 7 6 4 0 0 4 * (1)

© 2013 Sony Corporation Printed in China
<http://www.sony.net/>

VCT-SCM1

お買い上げいただきありがとうございます。
〔重要〕 本機は安全のための注意事項を守らないと、人身事故になることがあります。この取扱説明書には、事故を防ぐための重要な注意事項と製品の取りかたを示しています。この取扱説明書をよくお読みの上、製品を安全に使用してください。お読みになったあとは、いつでも見られるところに必ず保管してください。

よくあるお問い合わせ、質問受付時間などは

<http://www.sony.jp/support/>

使いか相談窓口
 フリーダイヤル ☎0120-333-020
 携帯電話・PHS一部に料金が ☎050-3754-9577
 FAX ☎0120-333-389

↓
 上記番号へ接続後、最初のガイダンスが流れている間に

「405」+「#」
 を押してください。直接、担当窓口へおつながります。

ソニー株式会社 〒108-0075 東京都港南区1-7-1



正しい取り付け
 正しい操作で
 安全運転

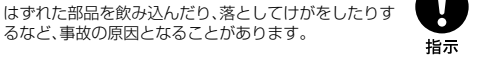
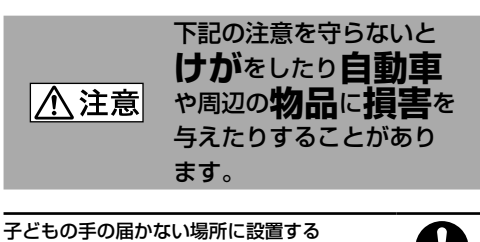
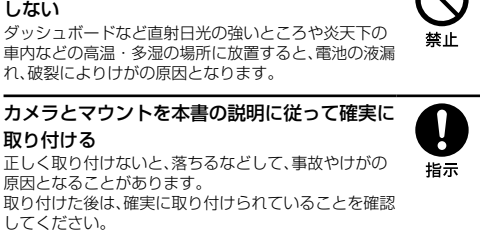
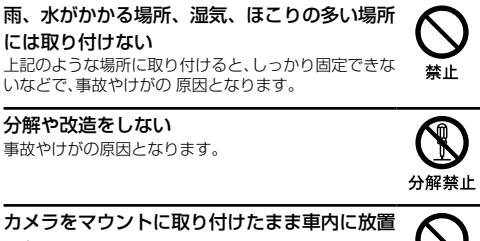
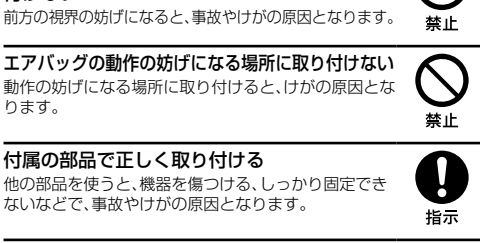
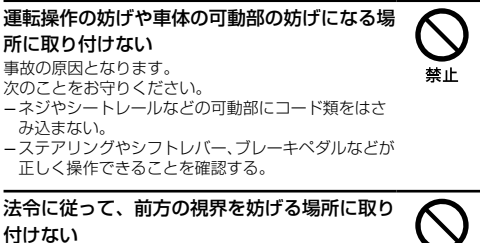
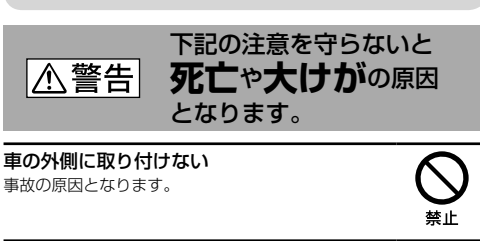
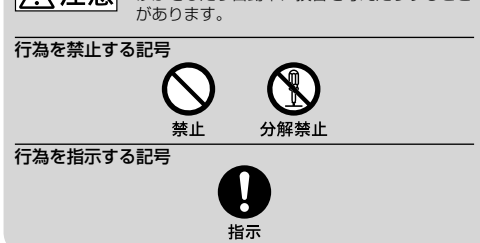
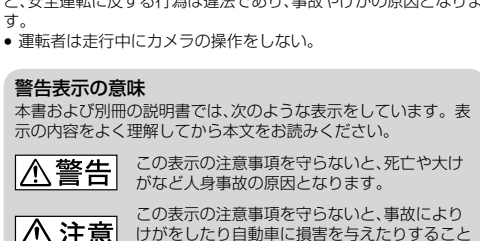
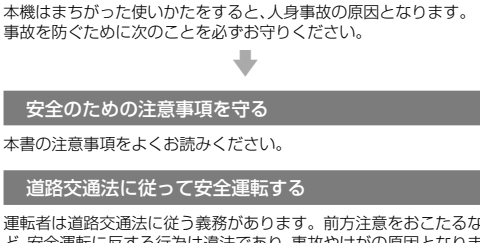
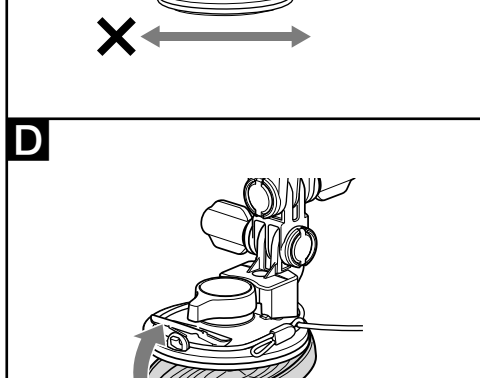
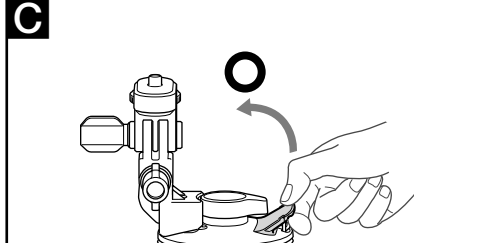
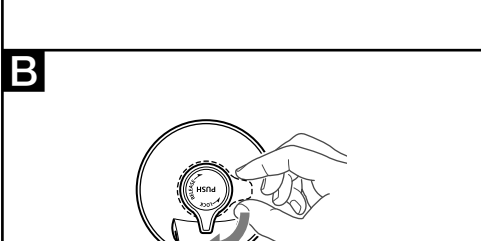
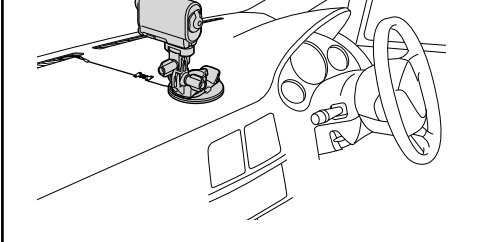
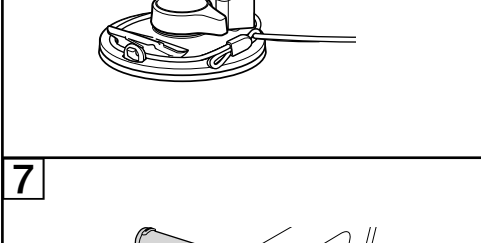
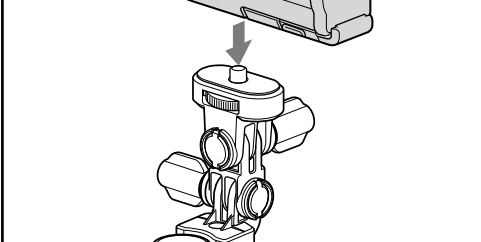
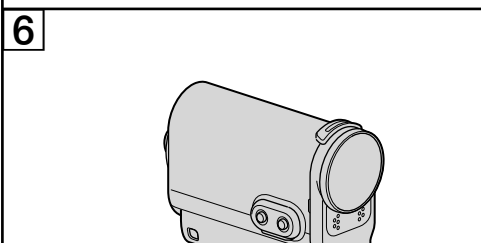
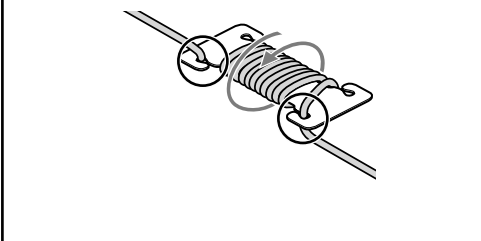
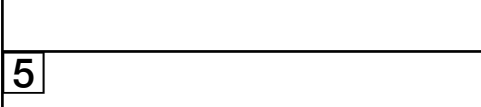
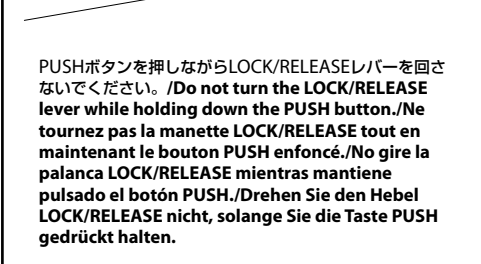
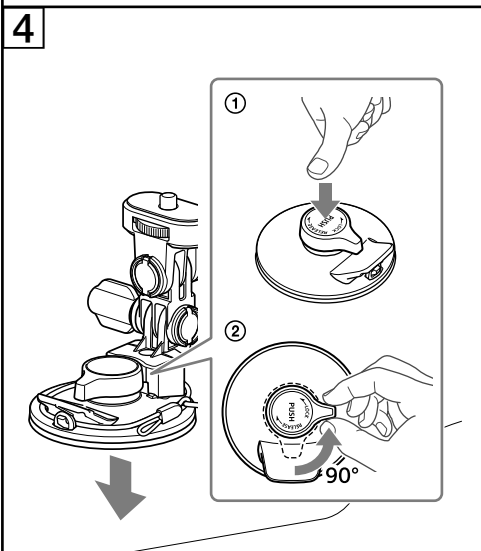
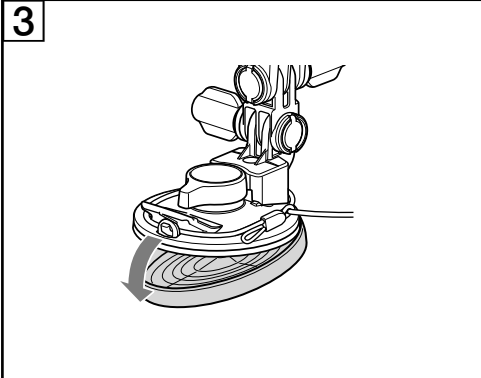
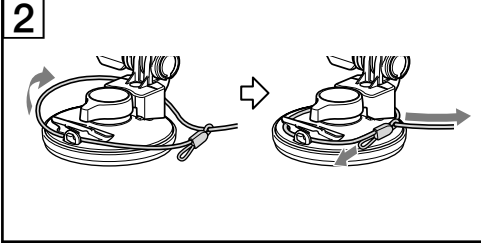
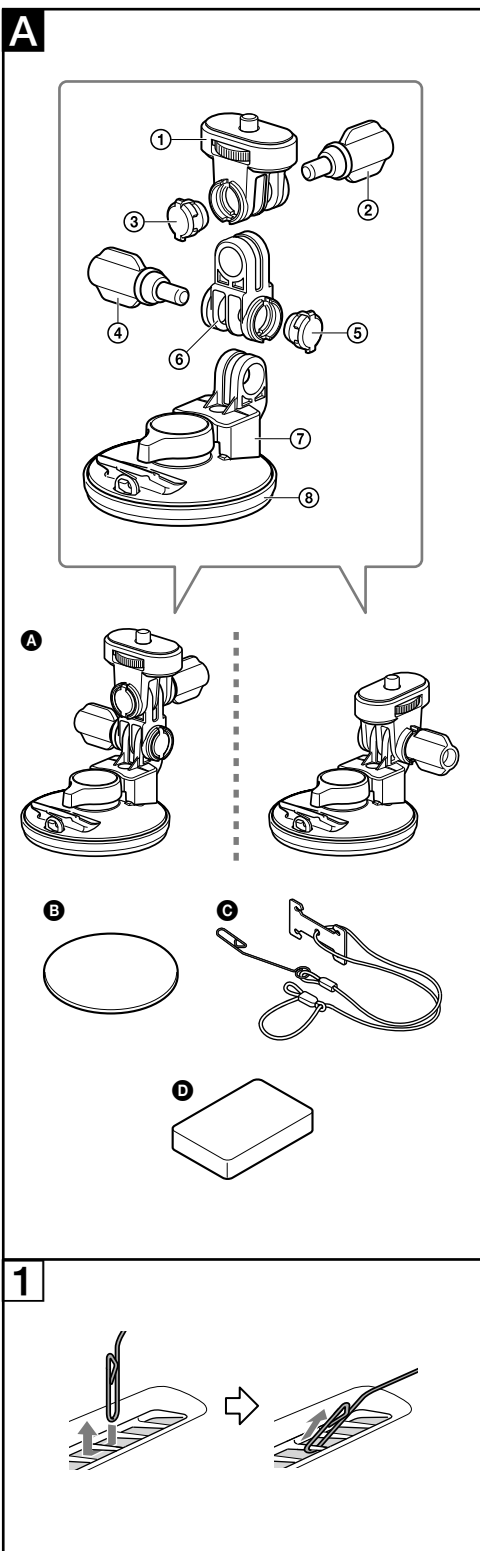

マウントをダッシュボードに放置しない
 マウントをダッシュボードに取り付けた状態で放置すると、ダッシュボードが変形することがあります。

禁止

使用上のご注意

- 運転中にカメラを操作しないでください。
- 万一、走行中に本機が落下すると、事故やけがの原因となることがあります。本機の落下を防ぐために、必ず付属のマウントストラップをお使いください。
- ダッシュボードなど直射日光の強いところや、炎天下の車内などの高温の場所ではカメラが劣化します。カメラの動作が停止するなどの予期せぬ動作を起こす可能性があります。取り付けるカメラの使用温度範囲内でお使いください。

詳しくはカメラに付属されている取扱説明書をご覧ください。

取付シート使用上のご注意

- 以下のようなダッシュボードの場合は、取付シートを使用してください。
 - Soft material, easily deformed with a finger, etc.
 - Rough, grain finish
- Choose the mounting location carefully. Practice installation before you actually mount the sheet, if necessary. It may be difficult to remove the mounting sheet from the dashboard as the adhesive strength of the mounting sheet is strong. **If you remove the mounting sheet forcibly, the dashboard may be deformed or damaged.**
- Allow 24 hours after sticking the mounting sheet on the dashboard before installing the mount on it.
- Removing the mounting sheet from the dashboard decreases the adhesive strength of the mounting sheet. It should not be reused after removal.

Notes on use of the mounting sheet

If not using the mounting sheet, the suction cup may not stick to the dashboard securely, and may damage or deform the dashboard.

— Soft material, easily deformed with a finger, etc.

— Rough, grain finish

Choose the mounting location carefully. Practice installation before you actually mount the sheet, if necessary. It may be difficult to remove the mounting sheet from the dashboard as the adhesive strength of the mounting sheet is strong. **If you remove the mounting sheet forcibly, the dashboard may be deformed or damaged.**

Allow 24 hours after sticking the mounting sheet on the dashboard before installing the mount on it.

Removing the mounting sheet from the dashboard decreases the adhesive strength of the mounting sheet. It should not be reused after removal.

Notes on suction cup

Put the cover on the suction cup when you take the mount off the dashboard. If the suction cup becomes dirty or scratched, its adhesive strength will be reduced.

Make sure that the surface of the dashboard where you intend to install the mount is clean. Dirty surfaces will make the adhesive strength of the suction cup weak, and may cause unstable installation of the mount.

Depending on the surface, be aware that the suction cup mount may leave a mark.

Doing any of the following may damage the suction cup.

- pressing/pulling the mount by its tab in a horizontal direction.
- inserting a hard object (key, blade, finger, etc.) between the suction cup and the dashboard.

The suction cup may be damaged if it is forcefully removed, or the mount is forced in a horizontal direction while still attached to the dashboard, or

if the temperature of the surface of the dashboard is low, for example, in winter or when used in a cold region, removal of the suction cup may be difficult.

Maintenance

Do not use any alcohol, detergent, etc.

Do not let water get into the mount as it may cause malfunction.

Make sure that the sponge is not so wet as to drip. Otherwise, dirt will be difficult to remove.

It takes time for the suction cup to dry completely. Do not use any tissue or towel to wipe off the surface of the suction cup.

Check periodically if the surface of the suction cup is dirty.

Tip

You can also use a soft, wet lint-free cloth to clean the surface of the suction cup.

Parts List (See fig. A)**Suction cup mount**

① Camera base

② Dial screw A

③ Screw cap

④ Joint arm A

⑤ Suction cup base

⑥ Cover

* This product can be configured for different heights. For the low

figuration, ①, ② and ③ are not used when assembling the mount. Be

sure to store them in a safe place.

⑦ Mounting sheet

⑧ Strap

⑨ Cleaning sponge for suction cup

Installation (See fig. 1 - 7)**Before Installation**

Mount the mount on an area of the dashboard which is smooth and

horizontal.

Adjust the strap (See fig. 5)

To prevent the camera from dropping, hold the camera.

To remove (See fig. B - D)

When detaching the mount from the dashboard, reverse the attaching

procedure.

1 Turn the LOCK/RELEASE lever clockwise 90 degrees to unlock.

2 Pull the tab of the suction cup to remove.

3 Put the Cover on the suction cup.

Specifications

Total weight of camera and mounted accessories

Maximum 250 g (8.9 oz)

Dimensions

Approx. 102 mm × 83 mm × 68 mm (4 1/8 in × 3 3/8 in × 2 3/4 in) (w/h/d)

Suction cup dimensions

Approx. φ 65 mm (φ 2 5/8 in)

Mass

Approx. 110 g (3.9 oz)

Included items

Suction cup mount (1), Cover (1), Mounting sheet (1), Strap (1),

Cleaning sponge for suction cup (1), Set of printed documentation

Design and specifications are subject to change without notice.

主な仕様

積載可能な最大総重量 250 g 以下

最大外形寸法 約 102 mm × 83 mm × 68 mm

吸盤寸法 約 φ65 mm (幅×高さ×奥行)

質量 約 110 g

同梱物 サクシヨンカップマウント(1)、

吸盤保護カバー(1)、取付シート(1)、

マウントストラップ(1)、

クリーニングスポンジ(1)、印刷物一式

仕様および外観は、改良のため予告なく変更することがありますがご

了承ください。

English

Notice for the customers in the countries applying EU Directives

Manufacturer: Sony Corporation, 1-7-1 Konan Minato-ku Tokyo, 108-0075 Japan

For EU product compliance: Sony Deutschland GmbH, Hedelfinger Strasse

61, 70327 Stuttgart, Germany

Precautions**Safety precautions**

Do not install the mount on the exterior of the vehicle.

A driver is obliged to follow traffic laws. Violation of road safety

rules, such as neglecting "proceed with caution," etc., is illegal, and it

may result in an accident or injury.

Do not operate your camera while driving.

Do not install the unit in locations which might hinder driving

operations. Doing so may cause an accident. Observe the following.

- Do not place cords around parts such as screws, etc., or moving parts such as seat rails.

Make sure that the steering wheel, shift lever, brake pedals, etc., can be

operated properly.

Do not install the unit in locations which might hinder forward vision if

compliance with local regulations. Hindering forward vision may result

in an accident or injury.

Do not install the unit in a place which might compromise air bag function.

Installing the unit in such a location may cause injury.

Install the unit securely using the supplied accessory parts. Use of other

than the supplied parts may damage this unit or cause parts to become

loose. It may result in an accident or injury.

Do not install the unit in a place exposed to rain or water, or in a location

subject to high humidity or dust. Installing the unit in the location

described above may cause a malfunction or injury.

Do not disassemble or modify. Doing so may result in an accident or injury.

Do not leave the camera attached to the mount in a car, leaving a

camera in a location subject to direct sun light, such as on a dashboard,

or in a hot or humid place, such as in a car, may result in battery

bursting/leakage, which could cause injury.

Do not leave the mount on a dashboard. Leaving it installed on a

dashboard may deform the dashboard.

Attach the camera and the mount securely following the instructions in

this manual. If they are not attached securely, the camera and/or mount

may fall and result in an accident or injury. Make sure they are attached

securely.

Keep the mount out of the reach of children. Swallowing a small part or

dropping it may result in an accident or serious injury.

If the mount becomes detached and falls while driving, a traffic accident or

injury may occur. To prevent this, be sure to use the supplied mount

strap.

If you operate the unit in a location subject to direct sunlight, such as on

a dashboard, or in a hot or humid place, such as in a car, this unit may

unexpectly malfunction. For example, the camera may stop operating.

Use the camera within its specified operating temperature range.

For details, refer to the operating instructions supplied with the camera.

Notes on use of the mounting sheet

In the case of the following dashboards, use the mounting sheet.

If not using the mounting sheet, the suction cup may not stick to

the dashboard securely, and may damage or deform the

dashboard.

— Soft material, easily deformed with a finger, etc.

— Rough, grain finish

Choose the mounting location carefully. Practice installation before you

actually mount the sheet, if necessary. It may be difficult to remove the

mounting sheet from the dashboard as the adhesive strength of the

mounting sheet is strong. **If you remove the mounting sheet forcibly,**

the dashboard may be deformed or damaged.

Allow 24 hours after sticking the mounting sheet on the dashboard

before installing the mount on it.

Removing the mounting sheet from the dashboard decreases the

adhesive strength of the mounting sheet. It should not be reused after

removal.

Notes on suction cup

Put the cover on the suction cup when you take the mount off the

dashboard. If the suction cup becomes dirty or scratched, its adhesive

strength will be reduced.

Make sure that the surface of the dashboard where you intend to install

the mount is clean. Dirty surfaces will make the adhesive strength of the

suction cup weak, and may cause unstable installation of the mount.

Depending on the surface, be aware that the suction cup mount may

leave a mark.

Doing any of the following may damage the suction cup.

- pressing/pulling the mount by its tab in a horizontal direction.
- inserting a hard object (key, blade, finger, etc.) between the suction cup and the dashboard.

The suction cup may be damaged if it is forcefully removed, or the mount

is forced in a horizontal direction while still attached to the dashboard, or

if the temperature of the surface of the dashboard is low, for example, in

winter or when used in a cold region, removal of the suction cup may be

difficult.

Maintenance

Do not use any alcohol, detergent, etc.

Do not let water get into the mount as it may cause malfunction.

Make sure that the sponge is not so wet as to drip. Otherwise, dirt will be

difficult to remove.

It takes time for the suction cup to dry completely. Do not use any tissue or

towel to wipe off the surface of the suction cup.

Check periodically if the surface of the suction cup is dirty.

Tip

You can also use a soft, wet lint-free cloth to clean the surface of the suction

cup.

Parts List (See fig. A)**Suction cup mount**

① Camera base

② Dial screw A

③ Screw cap

④ Joint arm A

⑤ Suction cup base

⑥ Cover

* This product can be configured for different heights. For the low

figuration, ①, ② and ③ are not used when assembling the mount. Be

sure to store them in a safe place.

⑦ Mounting sheet

⑧ Strap

⑨ Cleaning sponge for suction cup

Liste des pièces (voir fig. A)**Support à ventouse**

① Base de la caméra

②* Vis à molette A

③* Capuchon de vis

④* Bras articulé A

⑤ Base de la ventouse

⑥ Couverture

* Ce produit peut être configuré pour différentes hauteurs. Dans le cas

d'une hauteur réduite, ①, ② et ③ ne sont pas utilisés pour fixer le

support. Rangez-les en lieu sûr.

⑦ Feuille de montage

⑧ Dragonne

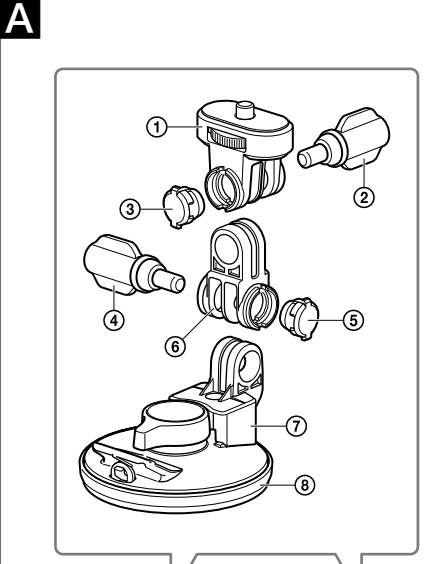

5

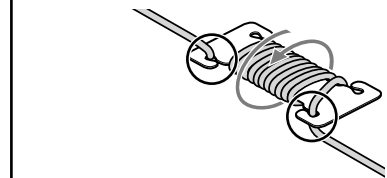

6

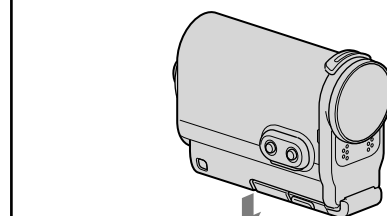

7

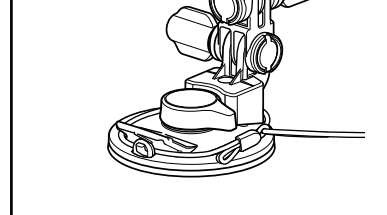

8

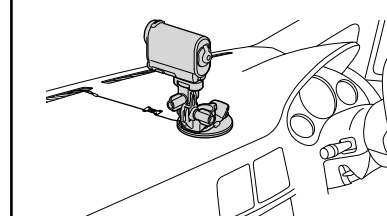

9

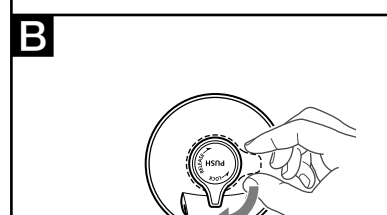

10

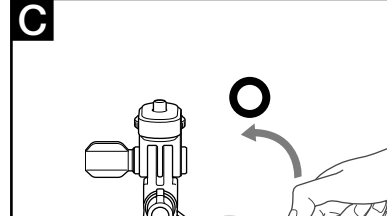

11



12



13



14

Verdraai de LOCK/RELEASE-hendel niet terwijl u de PUSH-knop ingedrukt houdt./Vrid inte på LOCK/RELEASE-spaken samtidigt som du håller PUSH-knappen intryckt./Non ruotare la leva LOCK/RELEASE mentre si tiene premuto il pulsante PUSH./Não rode a alavanca LOCK/RELEASE enquanto mantém premido o botão PUSH./Мην σπινάειτε το πομπό LOCK/RELEASE ενώ πιέζετε το κουμπάκι PUSH./Nie należy obracać dźwignię LOCK/RELEASE podczas naciskania przycisku PUSH.

Zorg ervoor dat het apparaat stevig gemonteerd is en behulp van de bijgeleverde onderdelen. Als u andere dan de bijgeleverde onderdelen gebruikt, kan het apparaat beschadigd raken of kunnen er onderdelen los komen te zitten. Dit kan leiden tot een ongeval of letsel.

Monteer het apparaat niet op een plaats waar het wordt blootgesteld aan regen of water, of op een plaats waar er overmatig veel vocht of stof aanwezig is. Als het apparaat op de hierboven beschreven plaats wordt geïnstalleerd, kan dit een storing of letsel veroorzaken.

Probeer het apparaat niet te demonteren of aan te passen. Dit kan leiden tot een ongeval of letsel.

Laat de camera nooit bevestigd aan het bevestigingsstuk in uw auto achter. Als u een camera achterliet op een plaats die blootgesteld wordt aan direct zonlicht (bv. op een dashboard) of in een warme of vochtige ruimte (bv. een auto), kan de batterij barsten of gaan lekken. Dit kan letsel veroorzaken.

Laat het bevestigingsstuk niet achter op een dashboard. Doet u in werel, dan kan het dashboard vervormd raken.

Bewestigt de camera en het bevestigingsstuk stevig volgens de instructies in deze handleiding. Als ze niet stevig bevestigd zijn, kunnen de camera en/of het bevestigingsstuk vallen, wat kan leiden tot een ongeval of letsel. Zorg er dus altijd voor dat ze stevig bevestigd zijn.

Houd het bevestigingsstuk buiten het bereik van kinderen. Als een kind een klein onderdeel inslikt of het apparaat laat vallen, kan dit leiden tot een ongeval of letsel.

Als het bevestigingsstuk losraakt en tijd tijden het rijden, kan dit leiden tot een verkeersongeval of letsel. Om dit te voorkomen, moet u steeds de bijgeleverde koord voor het bevestigingsstuk gebruiken.

Als u het apparaat gebruikt in een ruimte die blootgesteld is aan direct zonlicht (bv. op een dashboard) of in een warme of vochtige ruimte (bv. in een auto), is het mogelijk dat het apparaat oververhott, storingen gaat vertonen. De camera kan bijvoorbeeld stoppen met werken. Gebruik de camera binnen het voorgestelde bedrijfstemperatuurbereik. Raadpleeg de gebruiksaanwijzing van de camera voor meer informatie.

Opmerkingen bij het gebruik van het montagevel

- Gebruik voor de volgende types dashboards het montagevel.
- Als u het montagevel niet gebruikt, blijft de zuignap mogelijk niet goed kleven aan het dashboard en kan het dashboard beschadigd of vervormd raken.
- Zachte materialen die gemakkelijk met een vinger ingedrukt kunnen worden enz.
- Een ruw, korrelig oppervlak
- Denk goed na waar het apparaat wilt monteren. Oefen de montage indien nodig een aantal keer vooraleer u het vd daswerkkij aanbrengt. Mogelijk lukk het niet meer om het montagevel na het aanbrengen te verwijderen van het dashboard door de sterke kleeftkracht ervan. Als u het montagevel met kracht verwijderd, kunt u het dashboard beschadigen of vervormen.

A

- Wacht na het aanbrengen van het montagevel op het dashboard 24 uur vooraleer u het bevestigingsstuk erop bevestigd.
- Als u het montagevel van het dashboard verwijderd, gaat de kleeftkracht ervan achteruit. Gebruik het montagevel dus niet opnieuw nadat u het verwijderd hebt.

B

- Plaats het deksel op de zuignap wanneer u het bevestigingsstuk losmaakt van het dashboard. Het deksel wordt verwijderd van de zuignap als de kleeftkracht ervan achteruitgaat.
- Zorg ervoor dat de plaats waar u het bevestigingsstuk op het dashboard wilt aanbrengen proper is. Een vuil oppervlak zal de kleeftkracht van de zuignap sterk doen achteruitgaan, waardoor het bevestigingsstuk mogelijk niet stevig zal geïnstalleerd zijn.
- Merkt op dat het zuignapbevestiging afhankelijk van het oppervlak een markering kan maken op het oppervlak.
- De volgende handelingen kunnen de zuignap beschadigen:
 - Horizontaal drukken op / trekken aan het lipje van het bevestigingsstuk.
 - Een hard voorwerp (sleutel, mes, vinger enz.) tussen de zuignap en het dashboard plaatsen.
- De zuignap kan beschadigd raken als u deze met kracht verwijderd, als u het bevestigingsstuk horizontaal met kracht probeert te bewegen terwijl het nog aan het dashboard bevestigd is, of als u het bevestigingsstuk met kracht horizontaal probeert te bewegen vooraleer u de zuignap volledig van het dashboard hebt verwijderd.
- Als de temperatuur van het dashboardoppervlak laag is (bv. in de winter of bij gebruik in een koude regio), lukt het mogelijk niet goed om de zuignap te verwijderen.

C

- Horizontal clean the surface of the suction cup.
- Do not use sharp objects (keys, knives, fingers, etc.) between the suction cup and the dashboard.
- The suction cup can be damaged if you try to remove it with force, if you move it horizontally with force while it is still attached to the dashboard, or if you move it horizontally with force before you have completely removed the suction cup from the dashboard.
- If the surface temperature of the dashboard is low (e.g. in winter or when used in a cold region), it may not be possible to remove the suction cup.

D

- Place the cap on the suction cup when you remove the mounting bracket from the dashboard. The cap is removed from the suction cup as the adhesive force is lost.
- The cap can be damaged if you try to remove it with force, if you move it horizontally with force while it is still attached to the suction cup, or if you move it horizontally with force before you have completely removed the cap from the suction cup.

1

- Use a clean, smooth surface for the suction cup. A dirty or rough surface will reduce the adhesive force of the suction cup, making it difficult to attach and remove.
- The suction cup may be damaged if you try to remove it with force, if you move it horizontally with force while it is still attached to the dashboard, or if you move it horizontally with force before you have completely removed the suction cup from the dashboard.

2

- Place the cap on the suction cup when you remove the mounting bracket from the dashboard. The cap is removed from the suction cup as the adhesive force is lost.
- The cap can be damaged if you try to remove it with force, if you move it horizontally with force while it is still attached to the suction cup, or if you move it horizontally with force before you have completely removed the cap from the suction cup.

3

- Use a clean, smooth surface for the suction cup. A dirty or rough surface will reduce the adhesive force of the suction cup, making it difficult to attach and remove.
- The suction cup may be damaged if you try to remove it with force, if you move it horizontally with force while it is still attached to the dashboard, or if you move it horizontally with force before you have completely removed the suction cup from the dashboard.

4

- Use a clean, smooth surface for the suction cup. A dirty or rough surface will reduce the adhesive force of the suction cup, making it difficult to attach and remove.
- The suction cup may be damaged if you try to remove it with force, if you move it horizontally with force while it is still attached to the dashboard, or if you move it horizontally with force before you have completely removed the suction cup from the dashboard.

5

- Use a clean, smooth surface for the suction cup. A dirty or rough surface will reduce the adhesive force of the suction cup, making it difficult to attach and remove.
- The suction cup may be damaged if you try to remove it with force, if you move it horizontally with force while it is still attached to the dashboard, or if you move it horizontally with force before you have completely removed the suction cup from the dashboard.

6

- Use a clean, smooth surface for the suction cup. A dirty or rough surface will reduce the adhesive force of the suction cup, making it difficult to attach and remove.
- The suction cup may be damaged if you try to remove it with force, if you move it horizontally with force while it is still attached to the dashboard, or if you move it horizontally with force before you have completely removed the suction cup from the dashboard.

7

- Use a clean, smooth surface for the suction cup. A dirty or rough surface will reduce the adhesive force of the suction cup, making it difficult to attach and remove.
- The suction cup may be damaged if you try to remove it with force, if you move it horizontally with force while it is still attached to the dashboard, or if you move it horizontally with force before you have completely removed the suction cup from the dashboard.

8

- Use a clean, smooth surface for the suction cup. A dirty or rough surface will reduce the adhesive force of the suction cup, making it difficult to attach and remove.
- The suction cup may be damaged if you try to remove it with force, if you move it horizontally with force while it is still attached to the dashboard, or if you move it horizontally with force before you have completely removed the suction cup from the dashboard.

9

- Use a clean, smooth surface for the suction cup. A dirty or rough surface will reduce the adhesive force of the suction cup, making it difficult to attach and remove.
- The suction cup may be damaged if you try to remove it with force, if you move it horizontally with force while it is still attached to the dashboard, or if you move it horizontally with force before you have completely removed the suction cup from the dashboard.

10

- Use a clean, smooth surface for the suction cup. A dirty or rough surface will reduce the adhesive force of the suction cup, making it difficult to attach and remove.
- The suction cup may be damaged if you try to remove it with force, if you move it horizontally with force while it is still attached to the dashboard, or if you move it horizontally with force before you have completely removed the suction cup from the dashboard.

11

- Use a clean, smooth surface for the suction cup. A dirty or rough surface will reduce the adhesive force of the suction cup, making it difficult to attach and remove.
- The suction cup may be damaged if you try to remove it with force, if you move it horizontally with force while it is still attached to the dashboard, or if you move it horizontally with force before you have completely removed the suction cup from the dashboard.

12

- Use a clean, smooth surface for the suction cup. A dirty or rough surface will reduce the adhesive force of the suction cup, making it difficult to attach and remove.
- The suction cup may be damaged if you try to remove it with force, if you move it horizontally with force while it is still attached to the dashboard, or if you move it horizontally with force before you have completely removed the suction cup from the dashboard.

13

- Use a clean, smooth surface for the suction cup. A dirty or rough surface will reduce the adhesive force of the suction cup, making it difficult to attach and remove.
- The suction cup may be damaged if you try to remove it with force, if you move it horizontally with force while it is still attached to the dashboard, or if you move it horizontally with force before you have completely removed the suction cup from the dashboard.

14

- Use a clean, smooth surface for the suction cup. A dirty or rough surface will reduce the adhesive force of the suction cup, making it difficult to attach and remove.
- The suction cup may be damaged if you try to remove it with force, if you move it horizontally with force while it is still attached to the dashboard, or if you move it horizontally with force before you have completely removed the suction cup from the dashboard.

Montera inte enheten på plåster som hindrar körfunktioner. Det kan orsaka en olycka. Observera följande.

- Placera inte kablar runt t.ex. skruvar eller delar som rör sig t.ex. säterislåsar. Se till så att ratt, växelspåk, bromsar osv. kan användas fritt.
- Montera inte enheten på plåster som hindrar sikten fram i.
- Montera inte enheten på plåster som hindrar framklockans funktion.
- Montera inte enheten på en skidn plats kan det leda till skada.
- Montera enheten ordentligt med medföljande tillbehör. Enheten kan skadas inifrån eller delar kan lossna om andra tillbehör än de som medföljer används. Det kan leda till en olycka inifrån eller ett skador uppstår.
- Enheten får inte installeras på plåster som är utsatta för regn eller vatten eller på plåster där hög luftfuktighet eller damm förekommer. Om enheten installeras på en skidn plats som beskrivs ovan kan det leda till funktionsfel eller ett skador uppstår.
- Floreska inte isår eller modifiera enheten. Det kan leda till att en olycka inträffar eller ett skador uppstår.
- Lämnna inte kameran monterad på fästet i bilen. Om kameran lämnas på en plats som utsatts för direkt solljus som t.ex. på instrumentbrädan eller på en varm eller fuktigt plats som t.ex. i bilen, kan det leda till att batteriet går sönder/låcker vilket kan leda till skada.
- Floreska inte isår eller modifiera enheten. Det kan leda till att en olycka inträffar eller ett skador uppstår.
- Lämnna inte kameran monterad på fästet i bilen. Om kameran lämnas på en plats som utsatts för direkt solljus som t.ex. på instrumentbrädan eller på en varm eller fuktigt plats som t.ex. i bilen, kan det leda till att batteriet går sönder/låcker vilket kan leda till skada.
- Floreska inte isår eller modifiera enheten. Det kan leda till att en olycka inträffar eller ett skador uppstår.
- Lämnna inte kameran monterad på fästet i bilen. Om kameran lämnas på en plats som utsatts för direkt solljus som t.ex. på instrumentbrädan eller på en varm eller fuktigt plats som t.ex. i bilen, kan det leda till att batteriet går sönder/låcker vilket kan leda till skada.
- Floreska inte isår eller modifiera enheten. Det kan leda till att en olycka inträffar eller ett skador uppstår.
- Lämnna inte kameran monterad på fästet i bilen. Om kameran lämnas på en plats som utsatts för direkt solljus som t.ex. på instrumentbrädan eller på en varm eller fuktigt plats som t.ex. i bilen, kan det leda till att batteriet går sönder/låcker vilket kan leda till skada.

Opmerkingen bij het gebruik van het montagevel

- Gebruik voor de volgende types dashboards het montagevel.
- Als u het montagevel niet gebruikt, blijft de zuignap mogelijk niet goed kleven aan het dashboard en kan het dashboard beschadigd of vervormd raken.
- Zachte materialen die gemakkelijk met een vinger ingedrukt kunnen worden enz.
- Een ruw, korrelig oppervlak
- Denk goed na waar het apparaat wilt monteren. Oefen de montage indien nodig een aantal keer vooraleer u het vd daswerkkij aanbrengt. Mogelijk lukk het niet meer om het montagevel na het aanbrengen te verwijderen van het dashboard door de sterke kleeftkracht ervan. Als u het montagevel met kracht verwijderd, kunt u het dashboard beschadigen of vervormen.

A

- Wacht na het aanbrengen van het montagevel op het dashboard 24 uur vooraleer u het bevestigingsstuk erop bevestigd.
- Als u het montagevel van het dashboard verwijderd, gaat de kleeftkracht ervan achteruit. Gebruik het montagevel dus niet opnieuw nadat u het verwijderd hebt.

B

- Plaats het deksel op de zuignap wanneer u het bevestigingsstuk losmaakt van het dashboard. Het deksel wordt verwijderd van de zuignap als de kleeftkracht ervan achteruitgaat.
- Zorg ervoor dat de plaats waar u het bevestigingsstuk op het dashboard wilt aanbrengen proper is. Een vuil oppervlak zal de kleeftkracht van de zuignap sterk doen achteruitgaan, waardoor het bevestigingsstuk mogelijk niet stevig zal geïnstalleerd zijn.
- Merkt op dat het zuignapbevestiging afhankelijk van het oppervlak een markering kan maken op het oppervlak.
- De volgende handelingen kunnen de zuignap beschadigen:
 - Horizontaal drukken op / trekken aan het lipje van het bevestigingsstuk.
 - Een hard voorwerp (sleutel, mes, vinger enz.) tussen de zuignap en het dashboard plaatsen.
- De zuignap kan beschadigd raken als u deze met kracht verwijderd, als u het bevestigingsstuk horizontaal met kracht probeert te bewegen terwijl het nog aan het dashboard bevestigd is, of als u het bevestigingsstuk met kracht horizontaal probeert te bewegen vooraleer u de zuignap volledig van het dashboard hebt verwijderd.
- Als de temperatuur van het dashboardoppervlak laag is (bv. in de winter of bij gebruik in een koude regio), lukt het mogelijk niet goed om de zuignap te verwijderen.

C

- Horizontal clean the surface of the suction cup.
- Do not use sharp objects (keys, knives, fingers, etc.) between the suction cup and the dashboard.
- The suction cup can be damaged if you try to remove it with force, if you move it horizontally with force while it is still attached to the dashboard, or if you move it horizontally with force before you have completely removed the suction cup from the dashboard.

D

- Place the cap on the suction cup when you remove the mounting bracket from the dashboard. The cap is removed from the suction cup as the adhesive force is lost.
- The cap can be damaged if you try to remove it with force, if you move it horizontally with force while it is still attached to the suction cup, or if you move it horizontally with force before you have completely removed the cap from the suction cup.

1

- Use a clean, smooth surface for the suction cup. A dirty or rough surface will reduce the adhesive force of the suction cup, making it difficult to attach and remove.
- The suction cup may be damaged if you try to remove it with force, if you move it horizontally with force while it is still attached to the dashboard, or if you move it horizontally with force before you have completely removed the suction cup from the dashboard.

2

- Place the cap on the suction cup when you remove the mounting bracket from the dashboard. The cap is removed from the suction cup as the adhesive force is lost.
- The cap can be damaged if you try to remove it with force, if you move it horizontally with force while it is still attached to the suction cup, or if you move it horizontally with force before you have completely removed the cap from the suction cup.

3

- Use a clean, smooth surface for the suction cup. A dirty or rough surface will reduce the adhesive force of the suction cup, making it difficult to attach and remove.
- The suction cup may be damaged if you try to remove it with force, if you move it horizontally with force while it is still attached to the dashboard, or if you move it horizontally with force before you have completely removed the suction cup from the dashboard.

4

- Use a clean, smooth surface for the suction cup. A dirty or rough surface will reduce the adhesive force of the suction cup, making it difficult to attach and remove.
- The suction cup may be damaged if you try to remove it with force, if you move it horizontally with force while it is still attached to the dashboard, or if you move it horizontally with force before you have completely removed the suction cup from the dashboard.

5

- Use a clean, smooth surface for the suction cup. A dirty or rough surface will reduce the adhesive force of the suction cup, making it difficult to attach and remove.
- The suction cup may be damaged if you try to remove it with force, if you move it horizontally with force while it is still attached to the dashboard, or if you move it horizontally with force before you have completely removed the suction cup from the dashboard.

6

- Use a clean, smooth surface for the suction cup. A dirty or rough surface will reduce the adhesive force of the suction cup, making it difficult to attach and remove.
- The suction cup may be damaged if you try to remove it with force, if you move it horizontally with force while it is still attached to the dashboard, or if you move it horizontally with force before you have completely removed the suction cup from the dashboard.

7

- Use a clean, smooth surface for the suction cup. A dirty or rough surface will reduce the adhesive force of the suction cup, making it difficult to attach and remove.
- The suction cup may be damaged if you try to remove it with force, if you move it horizontally with force while it is still attached to the dashboard, or if you move it horizontally with force before you have completely removed the suction cup from the dashboard.

8

- Use a clean, smooth surface for the suction cup. A dirty or rough surface will reduce the adhesive force of the suction cup, making it difficult to attach and remove.
- The suction cup may be damaged if you try to remove it with force, if you move it horizontally with force while it is still attached to the dashboard, or if you move it horizontally with force before you have completely removed the suction cup from the dashboard.

9

- Use a clean, smooth surface for the suction cup. A dirty or rough surface will reduce the adhesive force of the suction cup, making it difficult to attach and remove.
- The suction cup may be damaged if you try to remove it with force, if you move it horizontally with force while it is still attached to the dashboard, or if you move it horizontally with force before you have completely removed the suction cup from the dashboard.

10

- Use a clean, smooth surface for the suction cup. A dirty or rough surface will reduce the adhesive force of the suction cup, making it difficult to attach and remove.
- The suction cup may be damaged if you try to remove it with force, if you move it horizontally with force while it is still attached to the dashboard, or if you move it horizontally with force before you have completely removed the suction cup from the dashboard.

11

- Use a clean, smooth surface for the suction cup. A dirty or rough surface will reduce the adhesive force of the suction cup, making it difficult to attach and remove.
- The suction cup may be damaged if you try to remove it with force, if you move it horizontally with force while it is still attached to the dashboard, or if you move it horizontally with force before you have completely removed the suction cup from the dashboard.

12

- Use a clean, smooth surface for the suction cup. A dirty or rough surface will reduce the adhesive force of the suction cup, making it difficult to attach and remove.
- The suction cup may be damaged if you try to remove it with force, if you move it horizontally with force while it is still attached to the dashboard, or if you move it horizontally with force before you have completely removed the suction cup from the dashboard.

13

- Use a clean, smooth surface for the suction cup. A dirty or rough surface will reduce the adhesive force of the suction cup, making it difficult to attach and remove.
- The suction cup may be damaged if you try to remove it with force, if you move it horizontally with force while it is still attached to the dashboard, or if you move it horizontally with force before you have completely removed the suction cup from the dashboard.

14

- Use a clean, smooth surface for the suction cup. A dirty or rough surface will reduce the adhesive force of the suction cup, making it difficult to attach and remove.
- The suction cup may be damaged if you try to remove it with force, if you move it horizontally with force while it is still attached to the dashboard, or if you move it horizontally with force before you have completely removed the suction cup from the dashboard.

15

- Use a clean, smooth surface for the suction cup. A dirty or rough surface will reduce the adhesive force of the suction cup, making it difficult to attach and remove.
- The suction cup may be damaged if you try to remove it with force, if you move it horizontally with force while it is still attached to the dashboard, or if you move it horizontally with force before you have completely removed the suction cup from the dashboard.

16

- Use a clean, smooth surface for the suction cup. A dirty or rough surface will reduce the adhesive force of the suction cup, making it difficult to attach and remove.
- The suction cup may be damaged if you try to remove it with force, if you move it horizontally with force while it is still attached to the dashboard, or if you move it horizontally with force before you have completely removed the suction cup from the dashboard.

17

- Use a clean, smooth surface for the suction cup. A dirty or rough surface will reduce the adhesive force of the suction cup, making it difficult to attach and remove.
- The suction cup may be damaged if you try to remove it with force, if you move it horizontally with force while it is still attached to the dashboard, or if you move it horizontally with force before you have completely removed the suction cup from the dashboard.

18

- Use a clean, smooth surface for the suction cup. A dirty or rough surface will reduce the adhesive force of the suction cup, making it difficult to attach and remove.
- The suction cup may be damaged if you try to remove it with force, if you move it horizontally with force while it is still attached to the dashboard, or if you move it horizontally with force before you have completely removed the suction cup from the dashboard.

19

- Use a clean, smooth surface for the suction cup. A dirty or rough surface will reduce the adhesive force of the suction cup, making it difficult to attach and remove.
- The suction cup may be damaged if you try to remove it with force, if you move it horizontally with force while it is still attached to the dashboard, or if you move it horizontally with force before you have completely removed the suction cup from the dashboard.

20

- Use a clean, smooth surface for the suction cup. A dirty or rough surface will reduce the adhesive force of the suction cup, making it difficult to attach and remove.
- The suction cup may be damaged if you try to remove it with force, if you move it horizontally with force while it is still attached to the dashboard, or if you move it horizontally with force before you have completely removed the suction cup from the dashboard.

21

- Use a clean, smooth surface for the suction cup. A dirty or rough surface will reduce the adhesive force of the suction cup, making it difficult to attach and remove.
- The suction cup may be damaged if you try to remove it with force, if you move it horizontally with force while it is still attached to the dashboard, or if you move it horizontally with force before you have completely removed the suction cup from the dashboard.

22

- Use a clean, smooth surface for the suction cup. A dirty or rough surface will reduce the adhesive force of the suction cup, making it difficult to attach and remove.
- The suction cup may be damaged if you try to remove it with force, if you move it horizontally with force while it is still attached to the dashboard, or if you move it horizontally with force before you have completely removed the suction cup from the dashboard.

23

- Use a clean, smooth surface for the suction cup. A dirty or rough surface will reduce the adhesive force of the suction cup, making it difficult to attach and remove.
- The suction cup may be damaged if you try to remove it with force, if you move it horizontally with force while it is still attached to the dashboard, or if you move it horizontally with force before you have completely removed the suction cup from the dashboard.

24

- Use a clean, smooth surface for the suction cup. A dirty or rough surface will reduce the adhesive force of the suction cup, making it difficult to attach and remove.
- The suction cup may be damaged if you try to remove it with force, if you move it horizontally with force while it is still attached to the dashboard, or if you move it horizontally with force before you have completely removed the suction cup from the dashboard.

25

- Use a clean, smooth surface for the suction cup. A dirty or rough surface will reduce the adhesive force of the suction cup, making it difficult to attach and remove.
- The suction cup may be damaged if you try to remove it with force, if you move it horizontally with force while it is still attached to the dashboard, or if you move it horizontally with force before you have completely removed the suction cup from the dashboard.

26

- Use a clean, smooth surface for the suction cup. A dirty or rough surface will reduce the adhesive force of the suction cup, making it difficult to attach and remove.
- The suction cup may be damaged if you try to remove it with force, if you move it horizontally with force while it is still attached to the dashboard, or if you move it horizontally with force before you have completely removed the suction cup from the dashboard.

27

- Use a clean, smooth surface for the suction cup. A dirty or rough surface will reduce the adhesive force of the suction cup, making it difficult to attach and remove.
- The suction cup may be damaged if you try to remove it with force, if you move it horizontally with force while it is still attached to the dashboard, or if you move it horizontally with force before you have completely removed the suction cup from the dashboard.

28

- Use a clean, smooth surface for the suction cup. A dirty or rough surface will reduce the adhesive force of the suction cup, making it difficult to attach and remove.
- The suction cup may be damaged if you try to remove it with force, if you move it horizontally with force while it is still attached to the dashboard, or if you move it horizontally with force before you have completely removed the suction cup from the dashboard.

29

- Use a clean, smooth surface for the suction cup. A dirty or rough surface will reduce the adhesive force of the suction cup, making it difficult to attach and remove.
- The suction cup may be damaged if you try to remove it with force, if you move it horizontally with force while it is still attached to the dashboard, or if you move it horizontally with force before you have completely removed the suction cup from the dashboard.

30

- Use a clean, smooth surface for the suction cup. A dirty or rough surface will reduce the adhesive force of the suction cup, making it difficult to attach and remove.
- The suction cup may be damaged if you try to remove it with force, if you move it horizontally with force while it is still attached to the dashboard, or if you move it horizontally with force before you have completely removed the suction cup from the dashboard.

31

- Use a clean, smooth surface for the suction cup. A dirty or rough surface will reduce the adhesive force of the suction cup, making it difficult to attach and remove.
- The suction cup may be damaged if you try to remove it with force, if you move it horizontally with force while it is still attached to the dashboard, or if you move it horizontally with force before you have completely removed the suction cup from the dashboard.

32

- Use a clean, smooth surface for the suction cup. A dirty or rough surface will reduce the adhesive force of the suction cup, making it difficult to attach and remove.
- The suction cup may be damaged if you try to remove it with force, if you move it horizontally with force while it is still attached to the dashboard, or if you move it horizontally with force before you have completely removed the suction cup from the dashboard.

Non installare l'unità in luoghi che potrebbero compromettere la funzionalità degli airbag.

- Non installare l'unità in luoghi simili potrebbe provocare lesioni.
- Installare saldamente l'unità utilizzando gli accessori in dotazione. L'uso di componenti diversi da quelli in dotazione potrebbe danneggiare l'unità o determinare l'allentamento dei componenti. Ciò potrebbe causare un incidente o lesioni gravi.
- Non installare l'unità in luoghi esposti a pioggia o acqua, o in luoghi soggetti ad elevata umidità o polvere. L'installazione dell'unità in un luogo simile a quelli sopra descritti potrebbe provocare un malfunzionamento o lesioni.
- Non disassemblare o modificare l'unità. Ciò potrebbe causare un incidente o provocare lesioni.
- Non lasciare la videocamera montata sul fissaggio in auto. Lasciare la videocamera in un luogo esposto alla luce diretta del sole, come il cruscotto, o in un luogo caldo o umido, come in auto, potrebbe causare l'esplosione o la perdita della batteria, con conseguenti lesioni.
- Non lasciare il fissaggio sul cruscotto. Lasciando il fissaggio installato sul cruscotto, quest'ultimo potrebbe deformarsi.
- Montare saldamente la videocamera e il fissaggio seguendo le istruzioni del presente manuale. Se non sono montati saldamente, la videocamera e/o il fissaggio potrebbero cadere e provocare incidenti o lesioni.
- Lämnna inte kameran monterad på fästet i bilen. Om kameran lämnas på en plats som utsatts för direkt solljus som t.ex. på instrumentbrädan eller på en varm eller fuktigt plats som t.ex. i bilen, kan det leda till att batteriet går sönder/låcker vilket kan leda till skada.
- Floreska inte isår eller modifiera enheten. Det kan leda till att en olycka inträffar eller ett skador uppstår.
- Lämnna inte kameran monterad på fästet i bilen. Om kameran lämnas på en plats som utsatts för direkt solljus som t.ex. på instrumentbrädan eller på en varm eller fuktigt plats som t.ex. i bilen, kan det leda till att batteriet går sönder/låcker vilket kan leda till skada.
- Floreska inte isår eller modifiera enheten. Det kan leda till att en olycka inträffar eller ett skador uppstår.
- Lämnna inte kameran monterad på fästet i bilen. Om kameran lämnas på en plats som utsatts för direkt solljus som t.ex. på instrumentbrädan eller på en varm eller fuktigt plats som t.ex. i bilen, kan det leda till att batteriet går sönder/låcker vilket kan leda till skada.

Notas sobre a utilização da película de fixação

- Não instale a unidade num local onde possa impedir o funcionamento da funcionalidade dos airbag.
- Av εγκαταστήστε τη μονάδα σε ένα τέτοιο σημείο, ενδέχεται να προκληθεί τραυματισμός.
- Εγκαταστήστε τη μονάδα με ασφάλεια χρησιμοποιώντας τα εξαρτήματα που παρέχονται. Η χρήση άλλων εξαρτημάτων ενδέχεται να οδηγήσει στη λειτουργία των αερίων πομπών ή σε πρόσκρουση βλάβη στη μονάδα ή να οδηγήσει στην απώλειά τους. Ενδέχεται να προκληθεί ατύχημα ή τραυματισμός.
- Μην αποσυναρμολογείτε ή τροποποιείτε τη μονάδα. Ενδέχεται να προκληθεί ατύχημα ή τραυματισμός.
- Μην αφήνετε την κάμερα συνδεδεμένη στη βάση στερέωσης στο αυτοκίνητο σας. Αν αφήσετε την κάμερα σε ένα σημείο που υπόκειται σε άμεσο ηλιακό φως, όπως στο ταμπλό ενός αυτοκινήτου, ή σε ένα θερμό ή γρήγο μόριο, όπως στο σπορτζ αυτοκίνητο, ενδέχεται να προκληθεί ατύχημα ή τραυματισμός.
- Μην αφήνετε τη βάση στερέωσης ενδέχεται να πέσουν και να προκαλέσει ατύχημα ή τραυματισμός. Βεβαιωθείτε ότι έχουν συνδεθεί σταθερά.
- Φυλάσσετε τη βάση στερέωσης μακριά από παιδιά. Αν καταπονή ένα μικρό εξάρτημα ή αν τους πιέσει, ενδέχεται να προκληθεί ατύχημα ή σοβαρός τραυματισμός.
- Μην αφήνετε τη βάση στερέωσης στο ταμπλό ή στον χώρο αυτοκινήτου. Αν την αφήσετε εγκαταστημένη στο ταμπλό, ενδέχεται να προκληθεί παραμόρφωση σε αυτό.
- Συνδέστε την κάμερα και τη βάση στερέωσης σταθερά, ακολουθώντας τις οδηγίες που είναι παρούσες. Εάν δεν τα συνδέετε σταθερά, ενδέχεται να προκληθεί ατύχημα ή τραυματισμός.
- Μην αφήνετε τη βάση στερέωσης ενδέχεται να πέσουν και να προκαλέσει ατύχημα ή τραυματισμός. Βεβαιωθείτε ότι έχουν συνδεθεί σταθερά.
- Φυλάσσετε τη βάση στερέωσης μακριά από παιδιά. Αν καταπονή ένα μικρό εξάρτημα ή αν τους πιέσει, ενδέχεται να προκληθεί ατύχημα ή σοβαρός τραυματισμός.
- Μην αφήνετε τη βάση στερέωσης στο ταμπλό ή στον χώρο αυτοκινήτου. Αν την αφήσετε εγκαταστημένη στο ταμπλό, ενδέχεται να προκληθεί παραμόρφωση σε αυτό.

Nota sull'uso del foglio di fissaggio

- Non caso di montaggio, utilizzare il foglio di fissaggio.
- Se non si utilizza il foglio di fissaggio, la ventosa potrebbe non aderire saldamente al cruscotto, danneggiando o deformando il cruscotto stesso.
- Materiali molli, facilmente deformabile con un dito, ecc.
- Finalura ruvida, granulosa
- Scogliere con cura il punto di fissaggio. Fare una prova di installazione prima di montare effettivamente il fissaggio, se necessario. Potrebbe risultare difficile rimuovere il foglio di fissaggio dal cruscotto, poiché la forza adesiva del foglio di fissaggio è grande. Se si rimuove il foglio di fissaggio con la forza, il cruscotto potrebbe deformarsi o rimanere danneggiato.
- Lasciar trascorrere 24 ore dopo aver incollato il foglio di fissaggio sul cruscotto prima di installare la camera e il fissaggio.
- La rimozione del foglio di fissaggio dal cruscotto ne riduce la forza adesiva. Esso